



ISO 9001-2015
Certified Company



Honey Techno Plast

HTP-0310-00

(310L - Seafood Containers)



We Serve The Best

Honey Techno Plast is fast growing manufacturer of Rotational moulding products contains wide ranges of Insulated Box, Customized Pallets, Heavy Duty Water Tanks Chemical Storage Containers & Tanks. We have in house Design & Mould development facilities. We designed & developed Globally accepted European Standard products.

Product Dimension Details

Product	Dimensions (External) (mm)			Dimensions (Internal) (mm)			Volume
	Length	Width	Height	Length	Width	Height	Litres
310L	915	715	765	865	665	580	310

* Dimension tolerance 1 to 1.5%



Color Options



Product Features

- Robust unique Design products
- Food Grade, Virgin, UV Stabilized Raw Material
- High Insulation property with High density Foam
- Easy handling and user friendly products
- For ease of cleaning proper drainage are given in each products
- Universally accepted design
- Customised color possible* (MOQ 100 Pcs)
- In mould & Post mould stickers possible* (MOQ 500 Pcs)
- Engraving Possible* (As per requirement at extra cost)
- Sturdy impact resistance products

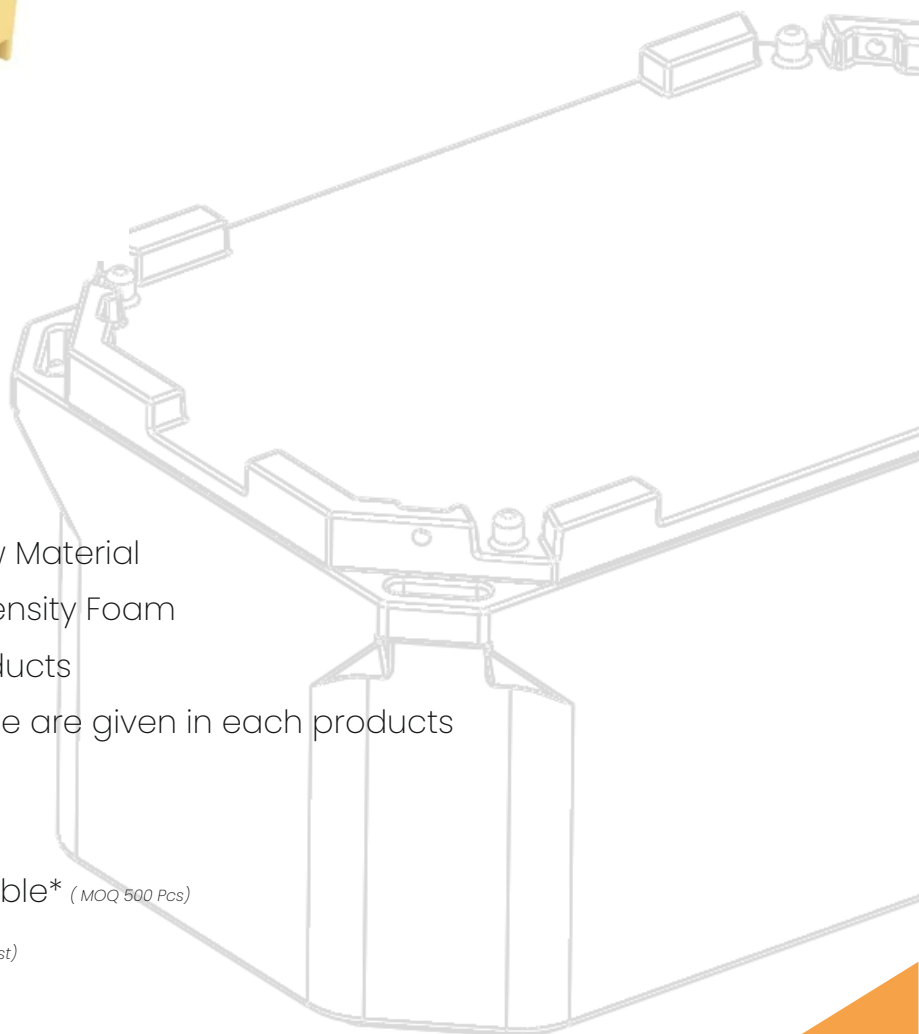

#startupindia

Honey Techno Plast

079 2963 2540 | +91 94 9961 2540 | sales@plassberry.com | www.plassberry.com
Plot 11, Aastha Industrial Estate, Zank Gam, Ta: Dehgam, Gandhinagar - 382305, Gujarat, India.

