



ISO 9001-2015  
Certified Company



# *Honey Techno Plast*

## **HTP-0070-00**

*(70L - Seafood Containers)*



### **We Serve The Best**

Honey Techno Plast is fast growing manufacturer of Rotational moulding products contains wide ranges of Insulated Box, Customized Pallets, Heavy Duty Water Tanks Chemical Storage Containers & Tanks. We have in house Design & Mould development facilities. We designed & developed Globally accepted European Standard products.

## Product Dimension Details

Product	Dimensions (External) (mm)			Dimensions (Internal) (mm)			Volume
	Length	Width	Height	Length	Width	Height	Litres
70L	745	480	385	675	410	290	70

\* Dimension tolerance 1 to 1.5%



## Color Options



## Product Features

- Robust unique Design products
- Food Grade, Virgin, UV Stabilized Raw Material
- High Insulation property with High density Foam
- Easy handling and user friendly products
- For ease of cleaning proper drainage are given in each products
- Universally accepted design
- Customised color possible\* (MOQ 100 Pcs)
- In mould & Post mould stickers possible\* (MOQ 500 Pcs)
- Engraving Possible\* (As per requirement at extra cost)
- Sturdy impact resistance products

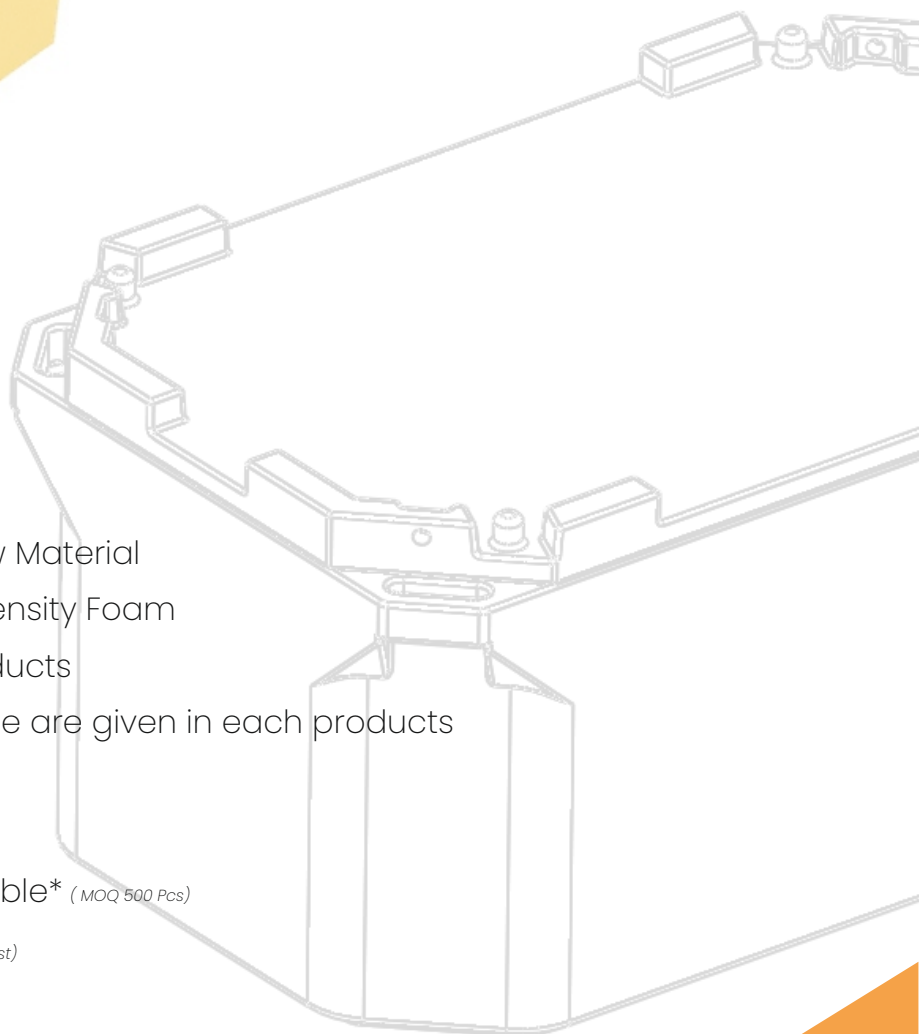

#startupindia

Honey Techno Plast

079 2963 2540 | +91 94 9961 2540 | sales@plassberry.com | www.plassberry.com  
Plot 11, Aastha Industrial Estate, Zank Gam, Ta: Dehgam, Gandhinagar - 382305, Gujarat, India.

